

# Design of a Compact Antenna Array for Satellite Navigation System Using Hybrid Matching Network

Juneseok Lee\*, Jaehoon Cho\*, Sang-Gyu Ha\*, Hosung Choo\*\* and Kyung-Young Jung<sup>†</sup>

**Abstract** – An antenna arrays for a satellite navigation systems require more antenna elements to mitigate multiple jamming signals. In order to maintain the small array size while increasing the number of antenna elements, miniaturization technique is essential for antenna design. In this work, an electrically small circular microstrip patch antenna with a 3 dB hybrid coupler is designed as an element antenna, where the 3 dB hybrid coupler can yield the circularly polarized radiation characteristic. The miniaturized element antenna typically has too large capacitance in GPS L1 and GLONASS G1 bands, making it difficult to match with a single stand-alone non-Foster matching circuit (NFMC) in a stable state. Therefore, we propose a new matching technique, referred to as the hybrid matching method, which consists of a NFMC and a passive circuit. This passive tuning circuit manages reactance of antenna elements at an appropriate capacitance without a pole in the operating frequency range. The antenna array is fabricated, and the measured results show a reflection coefficient of less than -10 dB and an isolation of greater than 50 dB. In addition, peak gain of the proposed antenna is increased by 22.3 dB compared to the antenna without the hybrid matching network.

**Keywords:** Non-Foster matching, GPS, Antenna, Controlled reception pattern antenna (CRPA).

## 1. Introduction

Satellite navigation systems including GPS, GLONASS, and GALILEO have been widely used in various areas especially in the defense industry [1]. As the number of usage of satellite navigation systems for unmanned aerial vehicles (UAVs) or missiles increases, a jamming method to paralyze the satellite navigation system has been actively developed [1, 2]. Therefore, anti-jamming technology is of crucial essence, which requires an antenna array to steer null points in the jamming directions [2]. More array elements bring in capability to generate more nulling points, however it also leads to an increase in size [3]. There are several methods to reduce the size. Applying a metamaterial, a high dielectric substrate, or a geometrically bending current path are good examples [4-6]. The use of metamaterials or bending current paths requires complicated shape fabrication, while the use of high dielectric substrates needs expensive manufacturing cost.

In this paper, a hybrid matching technique, based on both a non-Foster matching circuit (NFMC) [7,8] and a passive tuning circuit, is proposed to achieve simpler geometry with relatively low cost. Using the non-foster matching, we were able to insert multiple array elements in

a very small space, making them suitable for GPS array applications where antenna elements need to be inserted as much as possible in the limited space. First, an electrically small circular microstrip patch antenna is designed to fit seven antennas on a 5-inch circular plate for UAVs or missiles having limited space for the antenna array. Operating frequency bands of the antenna in this work are GPS L1 (1563-1587 MHz), and GLONASS G1 (1593 - 1610 MHz). A 3 dB hybrid coupler is then embedded into the antenna to achieve the circularly polarized radiation characteristic. The reactance of the electrically miniaturized antenna typically exhibits a large capacitance. However, according to our extensive study, designing an NFMC that operates above 1 GHz for such large negative capacitance is hardly possible due to stability issues. Therefore, we propose a new matching technique, referred to as the hybrid matching method, which consists of a NFMC and a passive circuit. This passive tuning circuit is employed to manage the reactance of antenna elements at an appropriate value without a pole in the operating frequency range. As a result, the antenna embedded with the passive circuit yields the reduced capacitance which is suitable for matching impedance to the NFMC. The measured results, such as reflection coefficients, radiation patterns, and isolation, show that the proposed method is suitable for use in small GPS array antennas.

## 2. Antenna array

The antenna array consists of 7 element antennas, a

<sup>†</sup> Corresponding Author: Department of Electronics and Computer Engineering, Hanyang University, Seoul, Korea.  
(kyjung3@hanyang.ac.kr)

\* Department of Electronics and Computer Engineering, Hanyang University, Seoul, Korea.

\*\* Department of Electronic and Electrical Engineering, Hongik University, Seoul, Korea.

Received: February 9, 2018; Accepted: April 3, 2018

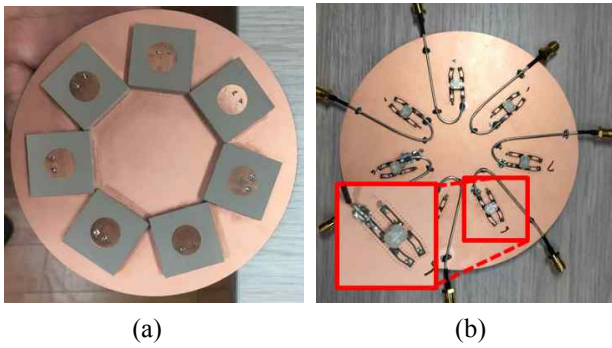

Fig. 1. Fabricated antenna array: (a) Top view (b) Bottom view

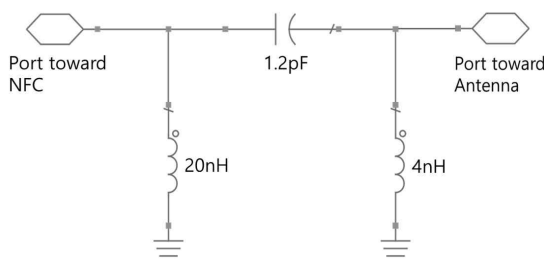

Fig. 2. Schematic of the passive circuit

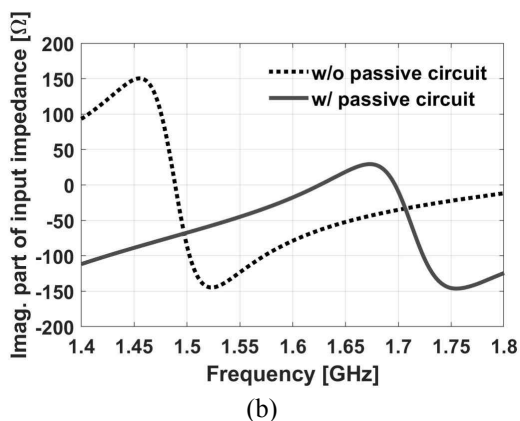
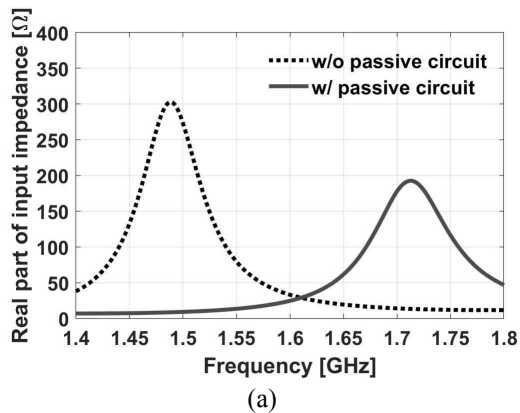

Fig. 3. Measured input impedance: (a) Real part (b) Imaginary part

ground, and a feed network. Note that in the feed network, a 3 dB hybrid coupler is utilized for circular polarization.

Fig. 1 shows top and bottom views of the fabricated antenna array. The ground plane is made with a radius of 63.5 mm and a thickness of 1 mm on a double-sided coated FR-4 substrate. On the top side of the ground, the 7 element antennas, fabricated on a CER-10 ( $\epsilon_r = 10$ ) substrate of  $27\text{ mm} \times 27\text{ mm} \times 6\text{ mm}$  size, are arrayed. On the other side, the 3 dB hybrid couplers (XC1400P-03S) from Anaren, Inc. are mounted between the element antennas and the SMA connectors. Fig. 2 shows the schematic of the passive tuning circuit for managing the imaginary parts of input impedance so that the absolute value is not too large. Otherwise, the NFMC cannot achieve conjugate impedance matching with the element antenna in a stable state.

The input impedances of antenna with and without the passive circuit are illustrated in Fig. 3. As shown in the figure, the reactance of the antenna without the passive circuit has nearly  $-120\ \Omega$  at 1.56 GHz and increases to  $-70\ \Omega$  at 1.61 GHz. After applying the passive tuning circuit, the reactance varies from  $-40\ \Omega$  to  $-10\ \Omega$  in the desired frequency range. Note that the reactance of the antenna with the passive circuit is used as a reference value for designing the NFMC.

### 3. Non-Foster Matching Circuit

Fig. 4 illustrates the schematic of the NFMC [7]. All elements except L4 and C5 are used twice since the schematic is symmetric. C1 and C4 block DC flow to RF ports, and L2 acts as an RF choke. C2 and C3 eliminate the minor leakage of the AC signal that is not filtered by the RF choke. R2 and R3 are used for biasing DC to operate BJT transistors. Oscillation from the transistors could be stabilized with L3, L4, R4, and C5. L3 and R4 take care of the oscillation in low frequency range, and L4 and C5 control the oscillation in the high frequency range. The BJTs used for this work are NE68133, and the values for each element are shown in Table 1.

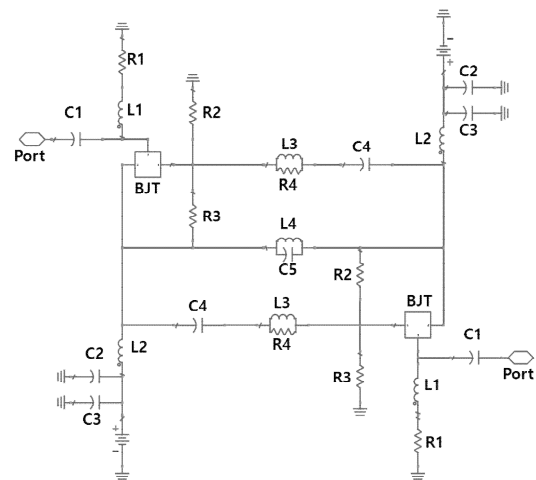
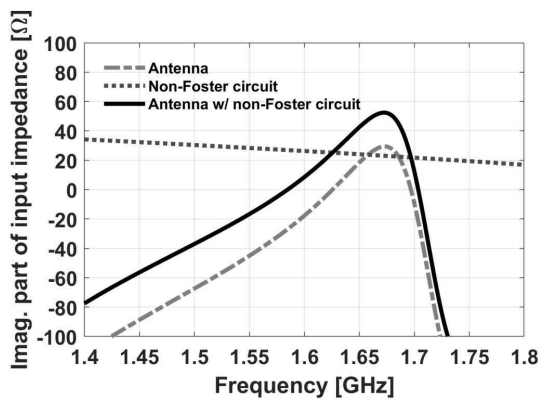

Fig. 4. Schematic of NFMC

**Table 1.** Element values

R1	R2	R3	R4	
100 Ω	16 kΩ	18 kΩ	100 Ω	
L1	L2	L3	L4	
56 nH	56 nH	140 nH	4.6 nH	
C1	C2	C3	C4	C5
10 pF	0.1 μF	680 pF	10 pF	7 pF



**Fig. 5.** Imaginary part of the input impedance

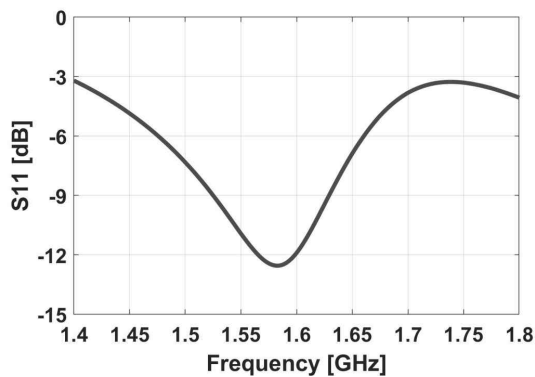

**Fig. 6.** S11 at input port of the antenna with the hybrid matching

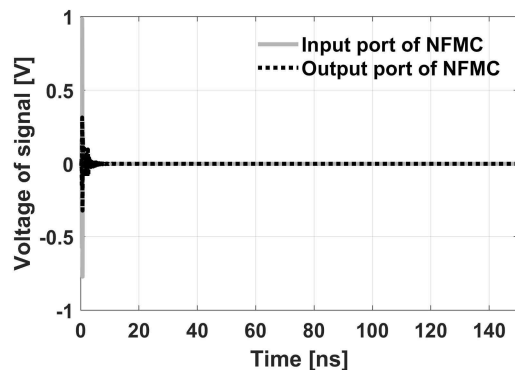

**Fig. 7.** Stability simulation in the time domain

The schematic is simulated with Advanced Design System, Keysight inc., and the simulation results are depicted in Fig. 5, Fig. 6, and Fig. 7. The input reactance

for the element antenna and NFMC is compared in Fig. 5. The combined results of the two reactances varies from  $-10 \Omega$  to  $10 \Omega$  in the L1 and G1 band. Thus, S11 at input port of the NFMC is below  $-10 \text{ dB}$  in the frequency range shown in Fig. 6. As alluded previously, NFMC has a critical stability issue. It is found that stability analysis in frequency domain is not appropriate for NFMC [9-11]. In the work, we verify the stability of our NFMC by a time domain simulation as suggested in [9]. Fig. 7 shows the input and output signals of the NFMC in the time domain. As shown in Fig. 7, the output signal does not diverge in the time domain.

#### 4. Results

The schematic in Fig. 4 is fabricated on a 1 mm thick FR4 substrate as shown in Fig. 8(a). The DC for biasing the transistors is powered by a portable 5V Li-ion battery through a USB type connector. For measurement, jig for fastening the batteries, NFMC, and antenna array, are made with a 3D printer [9] as depicted in Fig. 8(b). The fabricated antenna array is then measured and the results are shown in Fig. 9. Measured S11 is lower than  $-10 \text{ dB}$ , and the isolation is greater than  $50 \text{ dB}$  in the L1 and G1 bands. Fig. 10 depicts the measured and simulated

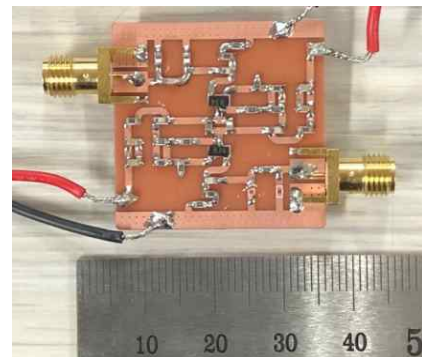

(a)

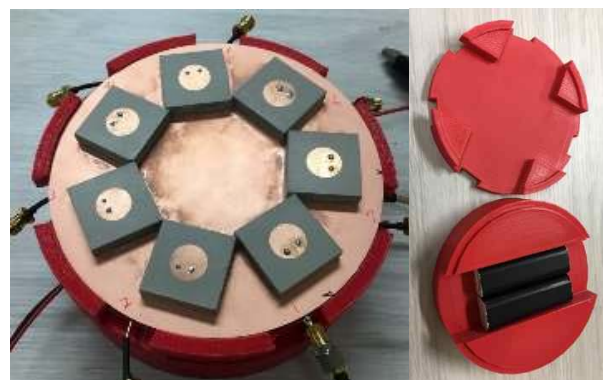

(b)

**Fig. 8.** Images of the fabricated antenna array: (a) NFMC (b) Jig and antenna array

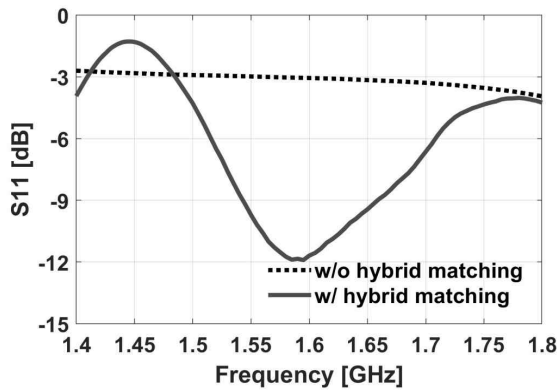

(a)

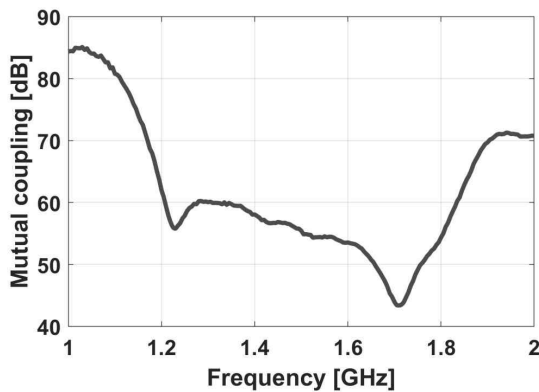

(b)

Fig. 9. Measured S-parameter of the antenna array: (a) S11 (b) Mutual coupling

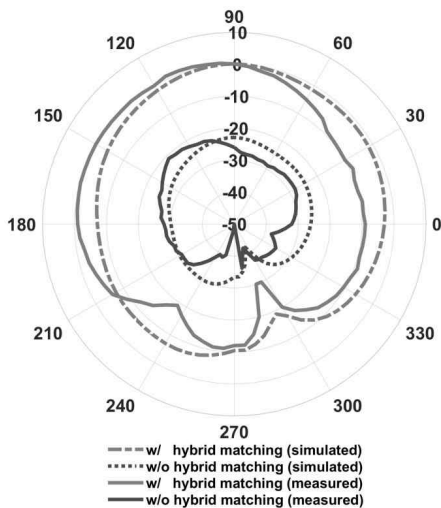

Fig. 10. Radiation patterns of the antenna

radiation patterns in unit of dBic for examining the right handed circularly polarized radiation of the antenna. The simulated and measured RHCP radiation pattern are similar to each other. With the hybrid matching network, a peak gain of 0.8 dBic is observed, while without the hybrid matching network, a peak gain of -21.5 dBic is detected.

## 5. Conclusion

In this paper, an antenna array with the hybrid matching network for satellite navigation system is proposed. A stand-alone NFMC is not suitable for compensating the large capacitance of the electrically small antenna employed in the proposed array since NFMC operating above 1 GHz is not easy to match with a high capacitance due to its stability issues. To solve the issue, a passive tuning circuit is embedded on the element antenna to reduce the reactance of the element antenna. As a result, the fabricated antenna array has a S11 of less than -10 dB in the GPS L1 and GLONASS G1 band, and an isolation greater than 50 dB in the frequency range of interest. In addition, circular polarization is achieved with 3 dB hybrid coupler. After the hybrid matching network is applied, the peak gain of the antenna is enhanced from -21.5 dBic to 0.8 dBic. From the results, the proposed antenna with the hybrid matching network is a good candidate for compact satellite navigation systems for missiles or UAVs.

## Acknowledgements

This research was supported by the Basic Science Research Program through the National Research Foundation of Korea (NRF) funded by the Ministry of Education (No. 2017R1D1A1B03034537) and by the Basic Science Research Program through the National Research Foundation of Korea (NRF) funded by the Ministry of Education (No. 2015R1A6A1A03031833).

## References

- [1] G. T. Schmidt, "INS/GPS technology trends," Massachusetts Inst of Tech Lexington MA2010.
- [2] G. Byun, J.-C. Hyun, S. M. Seo, and H. Choo, "Optimum array configuration to improve null steering time for mobile CRPA systems," *Journal of Electromagnetic Engineering and Science*, vol. 16, no. 2, pp. 74-79, 2016.
- [3] N. Yoon and C. Seo, "A 28-GHz Wideband 2×2 U-Slot Patch Array Antenna," *Journal of Electromagnetic Engineering And Science*, vol. 17, no. 3, pp. 133-137, 2017.
- [4] H. Piao, Y. Jin, J. Tak, and J. Choi, "Compact Mobile Quad-Band Slot Antenna Design for GPS L1, WiMAX, and WLAN Applications," *Journal of Electromagnetic Engineering and Science*, vol. 17, no. 2, 2017.
- [5] C.-J. Lee, K. M. Leong, and T. Itoh, "Compact dual-band antenna using an anisotropic metamaterial," in *Microwave Conference, 2006. 36th European*, 2006, pp. 1044-1047: IEEE.
- [6] S. Chen, G. Liu, X. Chen, T. Lin, X. Liu, and Z. Duan, "Compact dual-band GPS microstrip antenna using



- multilayer LTCC substrate,” *IEEE Antennas and Wireless Propagation Letters*, vol. 9, pp. 421-423, 2010.
- [7] K. S. Song, “Non-Foster impedance matching and loading networks for electrically small antennas,” The Ohio State University, 2011.
- [8] S.-G. Ha, J. Cho, and K.-Y. Jung, “Design of miniaturized microstrip patch antennas using non-Foster circuits for compact controlled reception pattern antenna array,” *Journal of Electromagnetic Engineering and Science*, vol. 17, no. 2, pp. 108-110, 2017.
- [9] E. Ugarte-Munoz, S. Hrabar, D. Segovia-Vargas, and A. Kirichenko, “Stability of non-Foster reactive elements for use in active metamaterials and antennas,” *IEEE Transactions on Antennas and Propagation*, vol. 60, no. 7, pp. 3490-3494, 2012.
- [10] S. D. Stearns, “Circuit stability theory for non-Foster circuits,” in *Microwave Symposium Digest (IMS), 2013 IEEE MTT-S International*, 2013, pp. 1-3: IEEE.
- [11] A. Elfrgani, R. Moussounda, and R. Rojas, “Time-domain stability analysis/design of negative impedance inverters and converters,” in *Microwave Symposium Digest (IMS), 2013 IEEE MTT-S International*, 2013, pp. 1-4: IEEE.

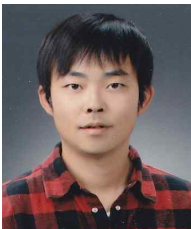

**Juneseok Lee** He received a B.S. in Electrical Engineering from Chungnam National University, Daejeon, Korea, in 2010. He also received an M.S. degree from the Department of Electronics and Computer Engineering at The University of Queensland, Brisbane, Australia, in 2011. He has researched for Ph.D at

Hanyang University, Seoul, Korea. He is interested in RF components including antenna design, wireless communication systems, wireless power transferring, and wireless body area network. Currently, his research is focused on designing microwave components for wireless body area network applications and antennas for next generation wireless communication systems.

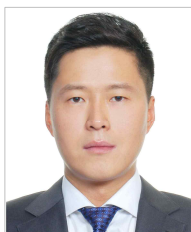

**Jeahoon Cho** He received a B.S. degree in Communication Engineering from Daejin University, Pocheon, Korea, and the M.S. and Ph.D. degrees in Electronics and Computer Engineering from Hanyang University, Seoul, Korea, in 2004, 2006, and 2015, respectively. From 2015 to August 2016, he was a

Postdoctoral Researcher at Hanyang University. Since September 2016, he has worked at Hanyang University, Seoul, Korea, where he is currently a Research Professor. His current research interests include computational electromagnetics, and electromagnetic pulse/electromagnetic interference/electromagnetic compatibility analysis.



**Sang-Gyu Ha** He received a B.S. degree in Electrical and Computer Engineering from Ajou University, Suwon, Korea, and a Ph.D. degree in Electronics and Computer Engineering from Hanyang University, Seoul, Korea in 2011 and 2017, respectively. Since July 2017, he has been with LG Electronics. His research areas are finite-difference time domain (FDTD), Non-Foster antennas, and 5G mm waves.



**Hosung Choo** He received his B.S. degree in Radio Science and Engineering from Hanyang University, Seoul in 1998 and his M.S. and Ph.D. degrees in Electrical and Computer Engineering from the University of Texas at Austin in 2000 and 2003, respectively. In September 2003, he joined the School

of Electronic and Electrical Engineering in Hongik University, Seoul, Korea, where he is currently a professor. His principal area of research is to use optimization algorithms for developing antennas and microwave absorbers. His research interests also include electrically small antennas for wireless communications, reader and tag antennas for RFID, on-glass and conformal antennas for vehicles and aircraft, and array antennas for GPS applications.



**Kyung-Young Jung** He received B.S. and M.S. degrees in Electrical Engineering from Hanyang University, Seoul, Korea in 1996 and 1998, respectively and a Ph.D. degree in Electrical and Computer Engineering from The Ohio State University, Columbus, Ohio in 2008. From 2008 to 2009, he was a

postdoctoral researcher at The Ohio State University, and from 2009 to 2010, he was an Assistant Professor with the Department of Electrical and Computer Engineering, Ajou University, Korea. Since 2011, he has worked at Hanyang University, where he is now an Associate Professor in the Department of Electronic Engineering. Dr. Jung was a recipient of the Graduate Study Abroad Scholarship from the National Research Foundation of Korea, the Presidential Fellowship from The Ohio State University, the Best Teacher Award from Hanyang University, and the Outstanding Research Award from the Korean Institute of Electromagnetic Engineering Society. His current research interests include computational electromagnetics, bio electromagnetics, and nano electromagnetics.